



Make It Yours.

# HYBRID 1

Cooler Master Gaming Chair



[www.coolermaster.com/warranty/](http://www.coolermaster.com/warranty/)



[www.coolermaster.com](http://www.coolermaster.com)



**North America - Cooler Master NA**  
1 N Indian Hill Blvd, Suite 200,  
Claremont, CA 91711, USA  
Tel: +1-888-624-5099

**Europe - Cooler Master Europe B.V.**  
Lodewijkstraat 1b, 5652AC Eindhoven,  
The Netherlands  
Tel: +31-(0)40-702-0900

**China - Cooler Master China**  
7th Floor, Building C, Hongqiao R&F  
Center, No.7, 958 Lane, Shenhong Rd.,  
Minhang District, Shanghai City 200051,  
China  
Tel: +86-21-51872177

Cooler Master Support:  
<https://account.coolermaster.com>

©2019 Cooler Master Technology Inc. All right  
Reserved. All trademarks are registered to their  
respective owners. Designed by Cooler Master.  
Made in China.



**Cooler Master Website**  
For the most updated  
information, please visit  
our official website:  
[www.coolermaster.com](http://www.coolermaster.com)



Make It Yours.

# HYBRID 1

Cooler Master Gaming Chair  
Instruction Manual

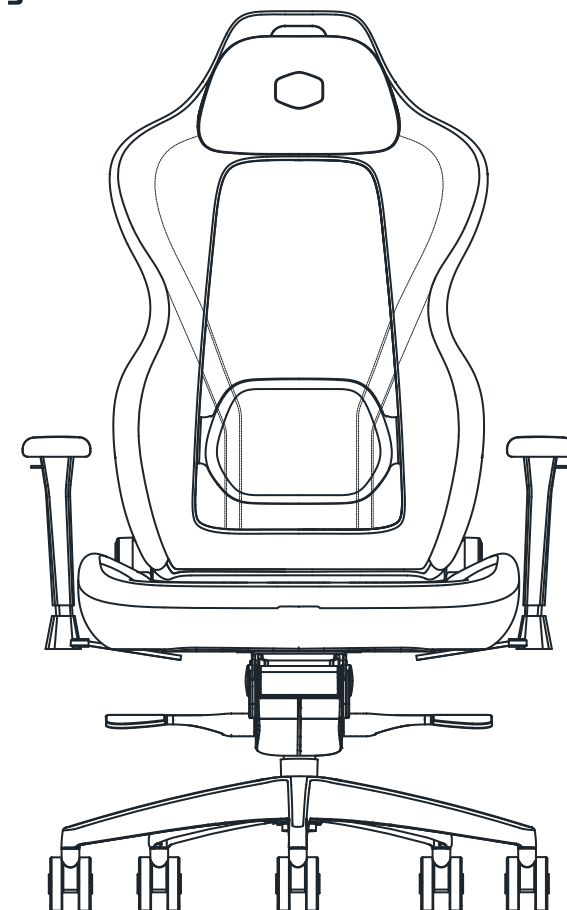

Installation Video





# HYBRID 1

Cooler Master Gaming Chair





## CONTENTS

---

Package Content	2
Installation Guide	3
• Installation Steps	3
• Completing Installation	3
Chair Dimensions	4
Warranty Information	6

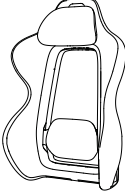
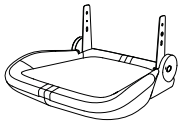
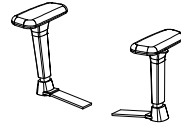
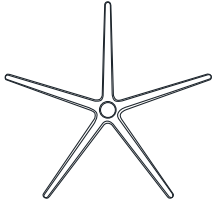
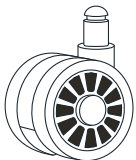
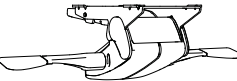

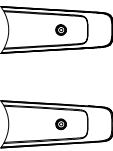
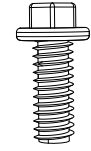
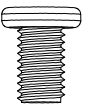
PACKAGE CONTENT

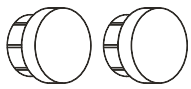
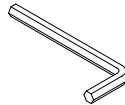
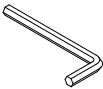
<p><b>A</b></p>  <p>Backrest x 1</p>	<p><b>B</b></p>  <p>Seatbase x 1</p>	<p><b>C</b></p>  <p>Armrest x 2</p>
<p><b>D</b></p>  <p>Base x 1</p>	<p><b>E</b></p>  <p>Performance wheels x 5</p>	<p><b>F</b></p>  <p>Tilt Mechanism x 1</p>
<p><b>G</b></p>  <p>Gas lift x 1</p>	<p><b>H</b></p>  <p>Recliner mechanism covers x 2</p>	<p><b>I</b></p>  <p>5/16" *25mm x 16</p>
<p><b>J</b></p>  <p>M5*12mm x 2</p>	<p><b>K</b></p>  <p>Flat washers x 16</p>	<p><b>L</b></p>  <p>Lock washers x 16</p>
<p><b>M</b></p>  <p>Cover studs x 2</p>	<p><b>N</b></p>  <p>Universal tool 5mm x 1</p>	<p><b>O</b></p>  <p>Universal tool 4mm x 1</p>

INSTALLATION GUIDE

**Step1**

- A x1
- B x1
- I x4
- K x4
- L x4
- N x1

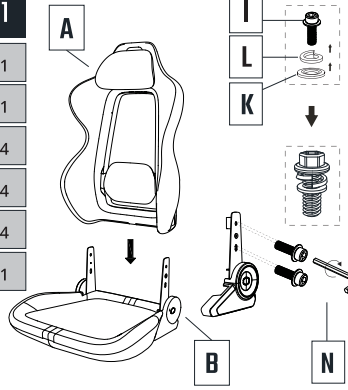

**Step2**

- C x2
- F x1
- I x12
- K x12
- L x12
- N x1

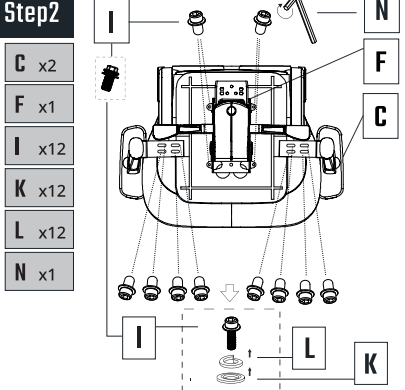

**Step3**

- H x2
- J x2
- M x2
- O x1

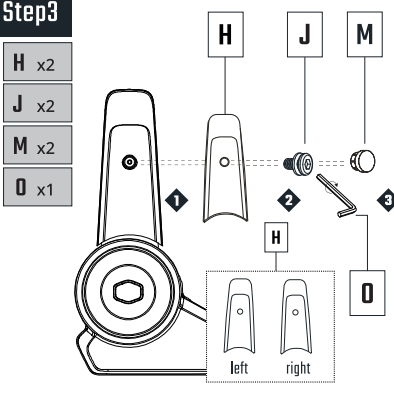

**Step4**

- D x1
- E x5
- G x1

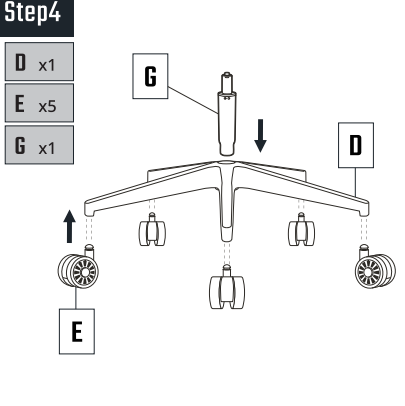

**Step5**



**Complete**



**HYBRID 1** GAMING CHAIR

**CHAIR DIMENSIONS**

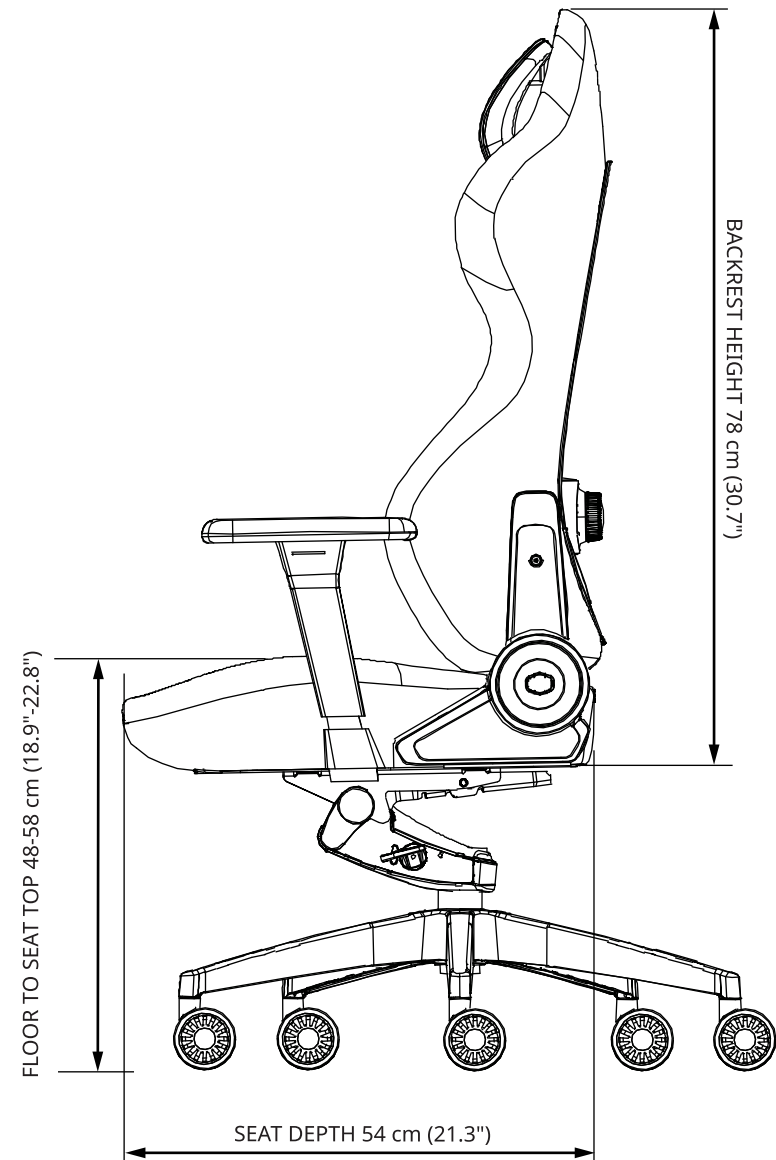
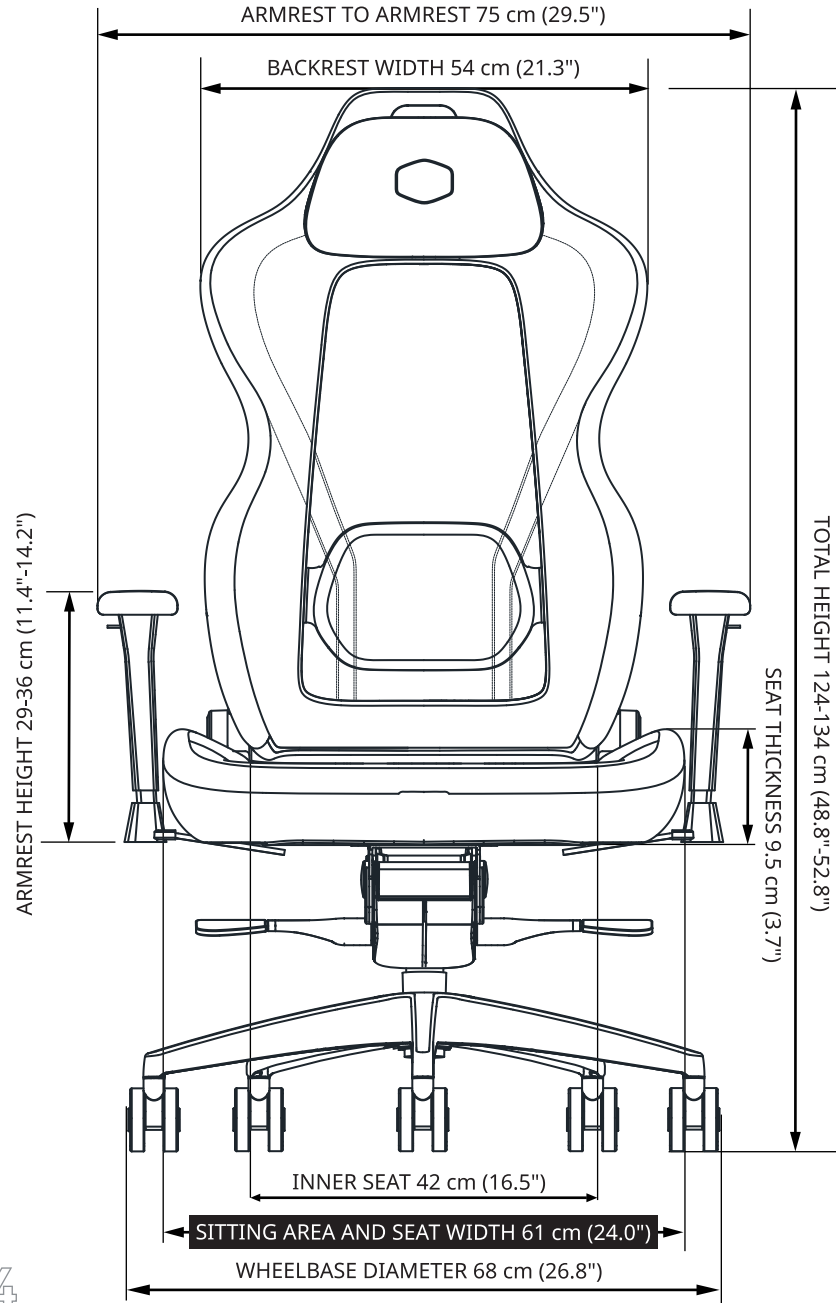





<p><b>Dutch (NL)</b></p> <p>Cooler Master biedt een beperkte hardwaregarantie van twee jaar voor dit apparaat vanaf de datum van aanschaf. Bewaar uw bon als aankoopbewijs. De aangeboden garantie dekt normaal gebruik. Defecten of schade die het gevolg is van onjuiste bediening, verkeerd gebruik, misbruik, ongevallen of nalatigheid van het product, wat niet de fout is van Cooler Master, zal uitgesloten zijn van garantiedekking.</p> <p>De garantie komt te vervallen door verwijdering of aanpassing van identificatielabels van producten of onderdelen.</p> <ol style="list-style-type: none"> <li>In het geval van een conflict tussen de garantie die wordt geboden door het land van het verkooppunt en deze handleiding, zal de garantie van het land van het verkooppunt het geldende document zijn.</li> <li>In het geval van storing van elektronische componenten of de noodzaak om accessoires aan te schaffen gedurende de garantieperiode, brengt u het terug naar de oorspronkelijke winkel van aanschaf.</li> </ol>	<p><b>Polish (PL)</b></p> <p>Produkt Cooler Master są objęte dwuletnią ograniczoną gwarancją na elementy sprzętowe, począwszy od daty zakupu. Prosimy zachować dowód zakupu. Gwarancja obejmuje tylko korzystanie z produktu zgodnie z jego przeznaczeniem. Wady i uszkodzenia powodowane niewłaściwą obsługą, użytkowaniem niezgodnym z przeznaczeniem, wypadkami lub zaniedbaniami, które nie wynikają z winy firmy Cooler Master, nie będą objęte gwarancją.</p> <p>Wszelkie przeróbki lub usuwanie elementów produktu lub etykiet identyfikujących części powoduje utratę uprawnień gwarancyjnych.</p> <ol style="list-style-type: none"> <li>W przypadku sprzeczności między warunkami gwarancji wynikającymi z przepisów powszechnych w kraju zakupu a warunkami zawartymi tutaj, pierwszeństwo mają warunki gwarancji ustalone przepisami w kraju zakupu.</li> <li>W przypadku awarii komponentów elektronicznych lub potrzeby zakupu akcesoriów w okresie gwarancji prosimy zwrócić się do sprzedawcy, u którego oryginalnie zakupiono produkt.</li> </ol>
<p><b>Portugal (PT)</b></p> <p>A Cooler Master oferece uma garantia limitada de dois anos para o hardware deste produto, com início na data de aquisição. Guarde o seu recibo como prova de compra. A garantia oferecida abrange a utilização normal. A cobertura da garantia exclui defeitos ou danos resultantes de operações inadequadas, utilizações indevidas, abusos, acidentes ou negligência do produto, que não sejam da responsabilidade da Cooler Master.</p> <p>A remoção ou alteração do produto ou de etiquetas de identificação de componentes anulará a garantia.</p> <ol style="list-style-type: none"> <li>Em caso de um conflito entre a garantia fornecida pelo país do ponto de venda e este manual, prevalecerá a garantia do país do ponto de venda.</li> <li>Em caso de avaria dos componentes eletrónicos ou necessidade de aquisição de acessórios durante o período de garantia, o produto deve ser devolvido à loja onde foi originalmente adquirido.</li> </ol>	<p><b>Russian (RU)</b></p> <p>Компания Cooler Master предоставляет на данное устройство ограниченную гарантию на оборудование сроком на два года, начиная от даты покупки. Сохраните кассовый чек для подтверждения покупки. Гарантия распространяется на нормальную эксплуатацию. Гарантия не распространяется на дефекты и повреждения, связанные с неправильной эксплуатацией, использованием не по назначению, происшествиями или небрежным обращением с изделием, и возникшие не по вине Cooler Master. Гарантия становится недействительной в случае удаления или изменения этикеток с номерами и обозначениями изделия и его деталей.</p> <ol style="list-style-type: none"> <li>В случае возникновения противоречий между гарантией, предоставленной в стране, в которой приобреталось изделие, и настоящим руководством, преимущественное значение имеет гарантия, выданная в месте покупки изделия.</li> <li>В случае неисправности электронных компонентов или необходимости приобретения принадлежностей в течение гарантийного периода обращайтесь в магазин, в котором было приобретено изделие.</li> </ol>
<p><b>Serbian (SR)</b></p> <p>Cooler Master obezbeđuje dve godine ograničene garancije na hardver za ovaj proizvod počevši od datuma kupovine. Sačuvajte račun kao dokaz o kupovini. Ponudena garancija pokriva normalnu upotrebu. Kvarovi ili oštećenja nastali usled nepravilnog rada, pogrešne upotrebe, zloupotrebe, nezgoda ili nemara prilikom korišćenja proizvoda, a koji nisu krivica kompanije Cooler Master, nisu pokriveni garancijom.</p> <p>Ova garancija se poništava u slučaju uklanjanja ili izmena proizvoda ili identifikacionih oznaka delova.</p> <ol style="list-style-type: none"> <li>U slučaju konflikta između garancije koja se daje u zemlji prodaje i ovog uputstva, garancija koja se daje u zemlji prodaje je dokument koji ima prednost.</li> <li>U slučaju kvara elektronskih komponenti ili potrebe kupovine delova tokom garantnog perioda, vratite proizvod na mesto gde je prvobitno bio kupljen.</li> </ol>	<p><b>Turkish (TR)</b></p> <p>Cooler Master, bu cihaz için, satın alma tarihinden itibaren başlayan, iki yıllık sınırlı bir donanım garantisi sağlar. Lütfen faturanızı satın alma kütüğüne saklayın. Sunulan garanti normal kullanımı kapsar. Hatallı kullanımdan kaynaklanan kusurlar veya hasarlar, yanlış kullanım, kötü kullanımlar, kazalar veya Cooler Master'in hatası olmayan ürünün ihmali garanti kapsamı dışındadır. Garanti, ürünlerin veya parçaların tanınmaları etiketlerinin kaldırılması veya değiştirilmesi ile geçersiz kılınır.</p> <ol style="list-style-type: none"> <li>Satış ülkesi tarafından verilen garanti ile bu kilavuz arasında bir anlaşmazlık olması durumunda, satış ülkesi garantisi geçerli olan belge olacaktır.</li> <li>Garanti süresi boyunca, elektronik parçaların arızalanması veya aksesuar satın alma gereksinimi olması durumunda, lütfen orijinal satın alma mağazasına geri dönün.</li> </ol>
<p><b>Ukrainian (UA)</b></p> <p>Cooler Master надає дворічну обмежену гарантію на апаратне забезпечення для цього пристрою, яка починає діяти з дати покупки. Зберігайте квитанцію для підтвердження покупки. Запропонована гарантія покриває нормальне використання. Дефекти чи пошкодження, які виникли внаслідок неправильної роботи, використання, порушення правил, нещасних випадків або недбалого поводження з виробом, які відбулися не з вини Cooler Master, не покриваються гарантією.</p> <p>Гарантія втрапить чинність у разі видалення чи заміни розпізнавальних етикеток виробів або деталей.</p> <ol style="list-style-type: none"> <li>У разі виникнення конфлікту між гарантією, наданою країною точки продажу, та цим посібником, переважачим документом є гарантія, надана країною точки продажу.</li> <li>У разі виникнення несправностей електронних деталей або необхідності придбання аксесуарів під час гарантійного періоду зверніться в магазин, де було придбано виріб.</li> </ol>	

Cooler Master Products: Limited Warranty  
This document describes the warranty terms for all Cooler Master product sold in Australia

**For Australia only:**  
Our goods come with guarantees that cannot be excluded under the Australian Consumer Law. You are entitled to a replacement or refund for a major failure and for compensation for any other reasonably foreseeable loss or damage. You are also entitled to have the goods repaired or replaced if the goods fail to be of acceptable quality and the failure does not amount to a major failure. Cooler Master Technology Inc. Telephone: +86-2-2225-3517 (standard international call charges apply.)

**Who the Warranty Protects:**  
This Warranty is valid to the original purchaser only.

**What the warranty protects:**  
This warranty is valid only for the Cooler Master Products distributed by authorized dealer(s) in Australia. Please contact Cooler Master for warranty information and services.  
Cooler Master Support: account.coolermaster.com

**What is and is Not Covered**  
It is important to note that our warranty is not an unconditional guarantee for the duration of the Program. Any replaced parts become the property of Cooler Master. The Program does not apply to the software component of a product or a product which has been damaged due to accident, misuse, abuse, improper installation, usage not in accordance with product specifications and instructions, natural or personal disaster, or unauthorized alterations, repairs or modifications. The Program does not cover any events such as below:

- Any damages unrelated to manufacturing defects.
- Any unsuitable environment or use of the product in Cooler Master Opinion.
- Any product which has been modified without official permission from Cooler Master, or on which the serial number or warranty sticker has been defaced, modified, or removed.

**Damage, deterioration or malfunction resulting from:**

- Accident, abuse, misuse, neglect, fire, water, lightning, or other acts of nature, commercial or industrial use, unauthorized product modification or failure to follow instructions included with the product.
- Third party products using Cooler Master Components will not be covered by warranty. See your vendor or the manufacturer for information about servicing.
- Repair or attempted repair by anyone not authorized by Cooler Master, Inc.
- Any shipment damages (claims must be made with the carrier).
- Unauthorized repairs to a Cooler Master product will void the warranty offered by the Program. Cooler Master reserves the right to refuse to service any product which has been altered, modified or repaired by non-Cooler Master Service personnel.
- Cooler Master does not warrant that this product will meet your requirements. It is your responsibility to determine the suitability of this product for your purpose.
- Removal or installation charges.
- You are responsible for the cost of shipping the product to Cooler Master. Cooler Master pays the cost of returning a product to you.
- Cooler Master reserves the right to replace the product with a service product at their sole discretion at any time.
- Product malfunction or damage resulting from liquids or moisture.
- All accessories that malfunction due to physical damage such as: USB cables, extension cables, adapter cables, adapters, power cords, screws, retention brackets, ear cups, and all other similar accessories.

**Limitation of Implied warranties:**  
THERE ARE NO WARRANTIES, EXPRESS OR IMPLIED, WHICH EXTEND BEYOND THE DESCRIPTION CONTAINED HEREIN INCLUDING THE IMPLIED WARRANTY OF MERCHANTABILITY AND FITNESS FOR A PARTICULAR PURPOSE.

**Exclusion of damages**  
COOLER MASTER'S LIABILITY IS LIMITED TO THE COST OF REPAIR OR REPLACEMENT OF THE PRODUCT. COOLER MASTER SHALL NOT BE LIABLE FOR:  
- DAMAGE TO OTHER PROPERTY CAUSED BY ANY DEFECT IN THE PRODUCT, DAMAGES BASED UPON INCONVENIENCE, LOSS OF USE OF THE PRODUCT, LOSS OF TIME, LOSS OF PROFITS, LOSS OF BUSINESS OPPORTUNITY, LOSS OF GOODWILL, INTERFERENCE WITH BUSINESS RELATIONSHIPS OR OTHER COMMERCIAL LOSS, EVEN IF ADVISED OF THEIR POSSIBILITY OF SUCH DAMAGES.  
- LOSS OF OTHER DAMAGES, WHETHER INCIDENTAL, CONSEQUENTIAL OR OTHERWISE  
- ANY CLAIM AGAINST THE CUSTOMER BY ANY OTHER PARTY

**Warranty Information:**  
If the goods is found with reasonable defect within the period of (refer to Table A,) starting on the first day of purchase (with proof of invoice), this is what you must do, to claim the warranty from the above address.

**Procedures:**

- Consumers should return to the shop where he/she has bought the goods. After confirming with the shop with a valid invoice, they may approach the distributor for RMA claim.
- After confirmed by the distributor that the goods was damaged due to natural causes, replacement and repair will be done by distributor (including brand new or refurbished goods)
- All faulty goods must return to the distributor, expenses for returning the faulty goods will be covered by the consumer, and distributor will cover the cost involved in the transporting of parts or repaired goods to the consumer.

Regarding all the expenses incurred in making the claim, and this is how you would claim:

- Within the valid warranty date, starting from the first day of issuing invoice, Retail shops will assist in confirmation with distributor for the consumer for the following.
  - If the damage was caused by the consumer, then the consumer should cover all expenses in fixing the product, if the product still can't be fixed, we would suggest consumer in buying a brand new product.
  - Product defect caused under natural use, expenses will be covered by the distributor.
- Faulty products with expired warranty dates, we would suggest consumer to purchase a brand new products, without undergoing for repairs.

For more warranty information, please visit our official website: <http://www.coolermaster.com/service/warranty.html>



Make It Yours.

